

For reference only. See data sheet for the detailed specifications.

Technical Specification



EIA WR	WR90
Frequency Range(GHz)	8.2 – 12.4
Insertion Loss(dB/PC)	0.2 Max.
VSWR	1.15:1 Max.
Average Power(KW CW)	2.0
Max. Air Pressure(Mpa)	0.2
Min. E-Bend Radius(mm)	66
Min. H-Bend Radius(mm)	120
Flange	FBP100(UBR100)
Jacket	Rubber
Operating Temp.(°C)	-55 ~ +85
Material	Cu
Length(mm)	200
Net Weight(Kg)	0.25 Around

Outline Drawing (Size: mm)

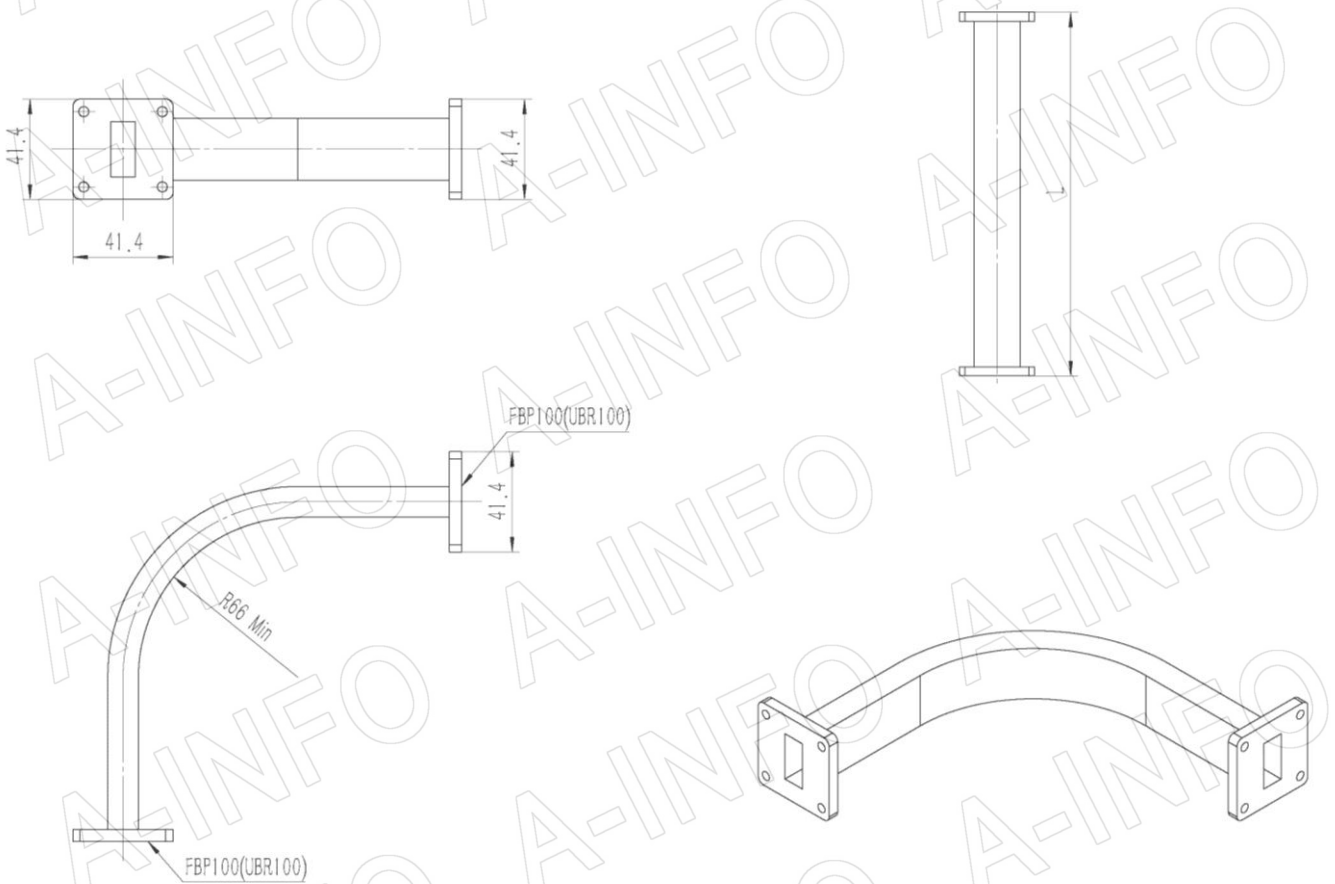

AINFO Inc.

Page 1 of 3

China(Beijing): Tel: (+86) 10-6266-7326,
China(Chengdu): Tel: (+86) 28-8519-2786,
USA: Tel: (+1) 949-639-9688,

(+86) 10-6266-7327 Fax: (+86) 10-6266-7379
(+86) 28-8519-3044 Fax: (+86) 28-8519-3068
(+1) 949-639-9608 Fax: (+1) 949-639-9670

Website: www.ainfoinc.com
Email: sales@ainfoinc.com

Flange Drawing (Size: mm)

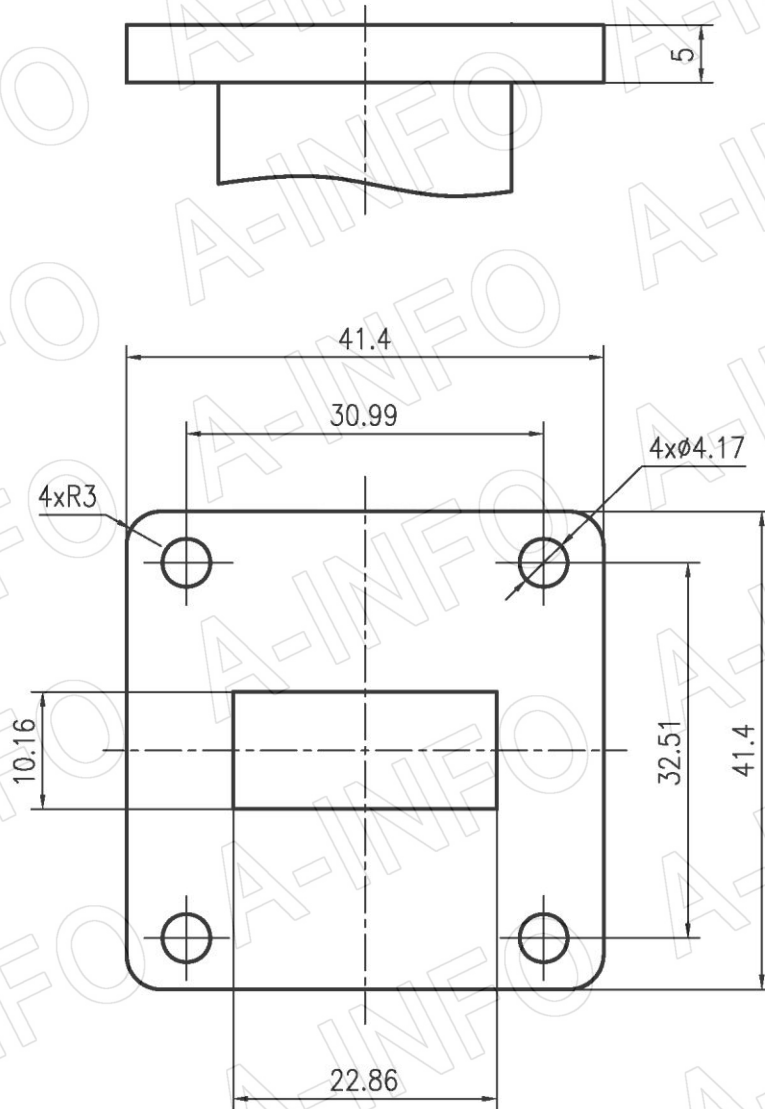

FBP100

AINFO Inc.

Page 2 of 3

China(Beijing): Tel: (+86) 10-6266-7326,
China(Chengdu): Tel: (+86) 28-8519-2786,
USA: Tel: (+1) 949-639-9688,

(+86) 10-6266-7327 Fax: (+86) 10-6266-7379
(+86) 28-8519-3044 Fax: (+86) 28-8519-3068
(+1) 949-639-9608 Fax: (+1) 949-639-9670

Website: www.ainfoinc.com
Email: sales@ainfoinc.com

Test Results

Attenuation (I.L.: 0.1540dB/PC Max.)

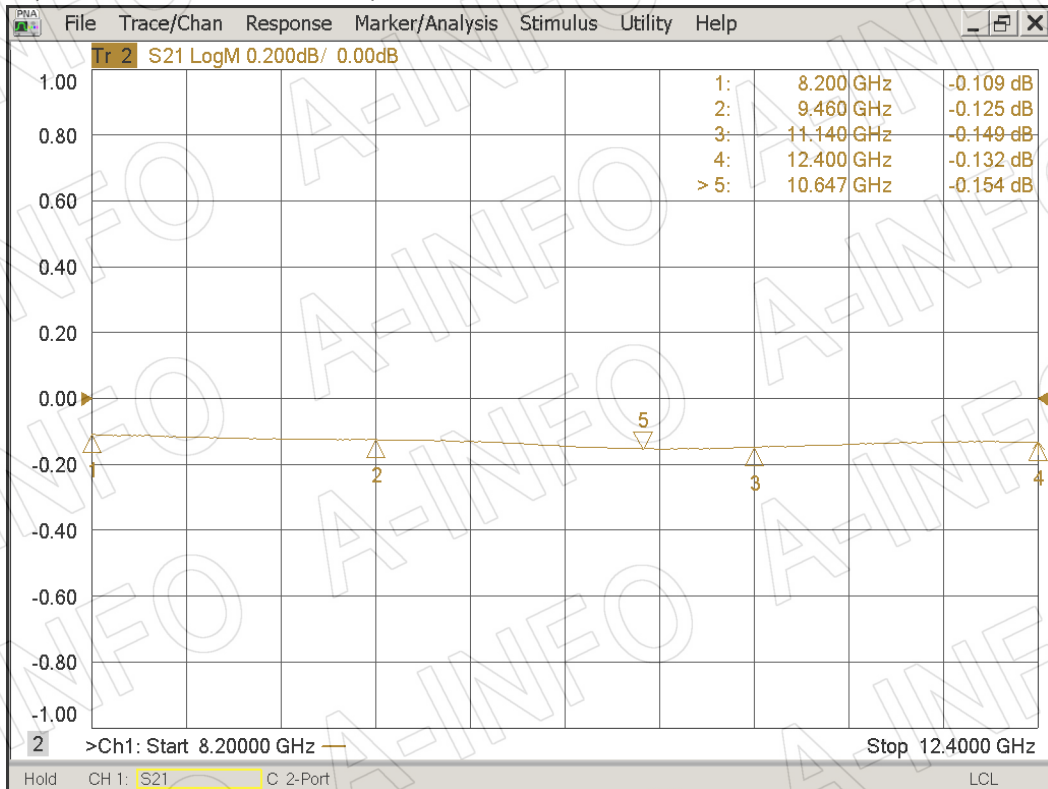

VSWR

